

Installation Instructions

Form:Installation Instructions:04-26

ALTRONIC



Table of Contents

Installation Instructions	1
1. SYSTEM DESCRIPTION	1
1.1 OVERVIEW	1
2. SYSTEM COMPONENTS	1
3. MOUNTING THE NGI-5000 LOGIC MODULE	1
3.1	1
3.2	1
3.3	1
4. MOUNTING FLYWHEEL GEAR/DRILLING FLYWHEEL HOLES	2
4.1	2
5. MOUNTING THE MAGNETIC PICKUPS	2
5.1	2
6. MOUNTING THE FLYWHEEL RESET PIN	2
6.1	2
6.2	3
7. MOUNTING THE CYCLE TRIGGER (4-CYCLE ENGINE ONLY)	3
7.1	3
7.2	3
8. LOGIC MODULE ELECTRICAL HOOK-UP	3
8.1	3
8.2	3
8.3	4
8.4	4
8.5	4
8.6	4
9. DC POWER HOOKUP -293030-XX: CABLE	5
9.1	5
9.2	5
9.3	5
9.4	5
10. PRIMARY WIRING	6
10.1	6
10.2	6
10.3	6
10.4	6
10.5	6
11. SHUTDOWN WIRING	7
11.1	7
11.2	7
12. SECONDARY WIRING	7
12.1	7
12.2	7
12.3	7
13. Figures	8
13.1 Wiring Diagram	8
13.2 Timing Curve	8
13.3 Pickup Mounting	9
13.4 Flywheel Hole Drilling	10
13.5 Wiring Diagram Unshielded	10

- 13.6 Wiring Diagram Shielded 11
- 13.7 Hookup Diagram Dual Output 12
- 13.8 Power Hookup 12
- 13.9 Wiring Hookup N and V 13
- 13.10 Output Module Dimensions 14
- 13.11 Diagnostic Module Dimensions 14
- 13.12 Shielded Harness 15
- 13.13 Shielded Harness 16
- 13.14 Conduit Length Adjustment 17
- 13.15 Magnet Holder 17
- 13.16 Magnet Holder Dimensions 18
- 13.17 Magnet Assembly 19
- 13.18 Hall Effect Pickup Dimensions 20
- 13.19 Magnetic Pickup Dimensions 21

Installation Instructions

1. SYSTEM DESCRIPTION

1.1 OVERVIEW

The NGI-5000 Logic Module is designed to be a drop in, plug and play replacement for the CPU-2000 Logic Module. It comes with two screens hosting information that is exported using the highly advanced Altronic Web Interface (AWI). One screen offers a touch interface for interacting with the module, while the other holds static information for quick viewing. Each screen is independent and uses only HDMI and USB for its interface to the rest of the system. A separate interface is used to program the engine application information, this uses web technology and does not require a separate terminal program to be downloaded.

Internally there is an ethernet backbone, and 485 two wire MODBUS for communications. To power the communications, the displays, and all of the expandability a System On Module (SOM) is used with high end computing power. In addition to the SOM a time critical and high specification microcontroller is used to interface with the input signals and drive the rest of ignition system.

2. SYSTEM COMPONENTS

3. MOUNTING THE NGI-5000 LOGIC MODULE

3.1

The NGI-5000 Logic Module is preferably panel-mounted off the engine in such a manner as to minimize exposure to vibration. Refer to drawing 299 103 for physical dimension details.

3.2

The Logic Module should be mounted within 50 feet (15 m) of the Output Module which is to be mounted on the engine.

3.3

Operating temperature range is -40°F. to 158°F. (-40°C. to 70°C.). Humidity specification is 0-95%, non-condensing. Housed in a NEMA 4 enclosure, the CPU-2000 Logic Module is splash resistant; however, the mounting site should provide as much protection from inclement weather as is practical. Avoid mounting the LCD display and keypad in direct sunlight.

4. MOUNTING FLYWHEEL GEAR/DRILLING FLYWHEEL HOLES

4.1

The Altronic NGI-5000 system requires a source of angular position pulses from the engine crankshaft. This can be a flywheel ring gear, a separately provided gear or specially drilled holes in the flywheel. The source of position pulses must meet the following requirements: - Must be ferrous material - Diameter of 18" or greater - No. of teeth or holes of 180 or greater - Maximum run-out referenced to the pickup of .007" Refer to drawings [209 102A](#) and 209 103 for further details.

5. MOUNTING THE MAGNETIC PICKUPS

5.1

The system requires two magnetic pickup signals: the angular position pulses from the gear or drilled holes and a reset pulse near the most advanced firing position desired for no. 1 cylinder. The pickups must be mounted to rigid brackets to maintain an air gap of $.015" \pm .005"$ with respect to the rotating gear or flywheel. It is also important for maximum signal efficiency that the centerline of the rotating part pass through the center of the pickup - see drawing [209 102A](#).

6. MOUNTING THE FLYWHEEL RESET PIN

6.1

Set the engine with no. 1 cylinder six (6) degrees ahead of the most advanced firing point. Mark a point on the flywheel directly opposite the pole piece of the reset magnetic pickup; then rotate the engine to a position convenient for drilling and tapping the flywheel at the point marked above. The reset pin should be made from a steel (magnetic) 1/4"-20 bolt or stud. See drawing [209 102A](#) for details.

6.2

Rotate the engine to the original set point and adjust the air gap between the end of the reset pin and the magnetic pickup at .01 0" using a feeler gauge.

7. MOUNTING THE CYCLE TRIGGER (4-CYCLE ENGINE ONLY)

7.1

The trigger magnet (260604, 260605 or 720002) must be mounted on the engine camshaft or other accessory drive operating at camshaft speed. An M8 (8 mm) tapped hole, 0.5 inches (13 mm) deep is required - see drawings [260604](#), [260605](#) or [720002](#) for details. The magnet MUST rotate on a diameter NOT EXCEEDING: - 6 inches (150 mm) for magnet 720002, or - 15 inches (375 mm) for magnet 260604 or 260605.

7.2

Set the engine on the COMPRESSION stroke of no. 1 cylinder with the reset pin DIRECTLY OPPOSITE the reset pickup. The Hall-effect pickup ([591014-x](#)) must be mounted DIRECTLY OPPOSITE the trigger magnet (section 8.1) coincident with the reset pickup and pin being lined-up - refer to drawing 209 060A. NOTE: The Hall-effect signal and the reset pickup signal must occur at the same time for the system to function. The Hall-effect pickup dimensions are shown on drawing 591 014. The air gap between the Hall-effect pickup and trigger magnet must not exceed .040" (1.0mm).

8. LOGIC MODULE ELECTRICAL HOOK-UP

8.1

The power connections to the NGI-5000 Legacy Logic Module must be in accordance with the National Electrical Code or other applicable country code. The NGI-5000 Logic Module is suitable for installation in Class I, Division 2, Group D locations.

8.2

The Logic Module must have its own 24 Vdc power connection. An external fuse near the power source is recommended for a power consumption of up to 5A max. See section 13.0 for other details regarding powering the CPU-2000 system.

8.3

Power wiring and signal (transducers) wiring must be in separate conduits and conduit entries into the Logic Module to avoid undesired electrical interaction. All conduit entries are sized for a 1/2"-14 NPT male conduit fitting. Separate as follows (refer to drawing no. 209 078): RIGHT CONDUIT ENTRY Power wiring and cable 293030-xx to Diagnostic or Output Module CENTER CONDUIT ENTRY Magnetic pickups and Hall-effect pickup LEFT CONDUIT ENTRY Control inputs, serial communications, and alarm outputs

8.4

RIGHT ENTRY: Input power supply wires (16 AWG minimum) should enter the right conduit entry and connect to the 24 Vdc supply terminals of terminal block. The interface cable 293030-xx connecting the Logic Module with either the Diagnostic or Output Module also enters through the right conduit entry. Refer to drawings 209 078 and 299 104 for connection details. CAUTION: Do not mistake the brown (pin "D") and light brown (pin "S") wires.

8.5

Run a separate conduit for the two (2) magnetic pickup cable assemblies. These should enter through the center entry in the CPU box and terminate as shown on drawing 209 078. 4-CYCLE ENGINE ONLY: The cable from the Hall-effect pickup also enters through the center entry and connects as shown.

8.6

LEFT ENTRY: A separate conduit must be used to the left-hand entry for all connections to the user interface terminal strips in the Logic Module. Use 24 AWG, UL style 1015 wire or shielded cable for these connections; the 24 AWG wire is available from Altronic under part no. 603102 (black) or 603103 (white). A. SHUTDOWN INPUT (terminal 4): Use to stop the ignition for engine shutdown. This input is open for normal operation of the system and is connected to engine ground to inhibit ignition firings. NOTE: This is a 5 volt low level signal. B. ALARM OUT (terminal 5), SHUTDOWN OUT (terminal 6), FIRE CONFIRM OUT (terminal 7): Three output switches are available for monitoring ignition system status. Each output consists of a solid state switch normally closed to a single common rail COMMON OUT (terminal 8). The switches are rated 75 mA@ 100 Vdc. These output switches are electrically isolated from all other terminals. The recommended hook-up is shown on drawing 209 078. For operational details, refer to the CPU-2000 Operating Instructions, form CPU-2000 01. C. 4-20 MA TIMING CONTROL INPUT: The 4-20 mA timing control loop connects to terminals 9(+) and 10(-). This input is electrically isolated from all other terminals; refer to drawings 209 078 and 209 079. D. MISC INPUT (terminal 11): Provides for control of various user selected features. This input is normally open; connect to engine ground to activate the selected feature (see drawing 209 078). NOTE: This is a 5 volt low level signal. For programming and operational details, refer to CPU-2000 Operating Instructions, form CPU-2000 01.

9. DC POWER HOOKUP -293030-XX: CABLE

9.1

The power connections to the CPU-2000 must be in accordance with the National Electrical Code or other applicable country code. The CPU-2000 is suitable for installation in Class I, Division 2, Group D locations.

9.2

It is necessary to split the control cable and power leads of the 293030 cable in an engine mounted junction box or conduit tee. This box should be separate from the main junction box used to terminate the output harness(es) to the ignition coils. The junction box should have three (3) 1/2" conduit entries (refer to drawing 209 077 or 209 077A): 1ST ENTRY - Conduit fitting of 293030 series connecting cable from the Output Module. 2ND ENTRY - Two leads from a source of nominal 24 Vdc (20-32 Vdc). The negative of the 24 Vdc supply MUST be common with engine ground. Refer to drawing 209 120 for details of the power hookup. 3RD ENTRY - The gray jacketed control cable from the 293030 series cable connecting to either the Diagnostic or Logic Module.

9.3

The CPU-2000 system can be powered in one of the following ways: A. 24 volt battery with charger. B. DC power supply capable of furnishing 24-28 Vdc. NOTE: The negative (-) of the 24 Vdc supply MUST BE COMMON WITH ENGINE GROUND. Engines using positive ground DC accessories or starter motors will require a separate dedicated power supply for the CPU-2000.

9.4

IMPORTANT: For proper operation of the CPU-2000 system, voltage and current supplied must be sufficient during all selected modes of operation. Drawing 209 120 provides these details regarding the DC power hook-up: 1. CURRENT DRAW PER SYSTEM - formula varies depending on number of outputs used, engine cycle and RPM, and the use of the multi-strike feature. 2. MINIMUM WIRE GAUGE REQUIREMENTS - Chart 1 of drawing [209120](#) gives the requirement vs. the length of run between the power source and the CPU-2000 Output Module. 3. MULTIPLE ENGINE INSTALLATIONS - Multiply current required per system by the number of engines. Where more than one engine is powered from a common power source, see Chart 2 of drawing [209120](#) for the minimum wire size required.

10. PRIMARY WIRING

10.1

The main wiring harness (293023-x, 293026-x, or 293027-x) connects the Output Module to the engine junction box. Refer to drawing [509025](#) if it is desired to shorten the conduit length of the harness. Insert the connector into the Altronic CPU-2000 Output Module receptacle and tighten hand-tight; then carefully tighten an additional one-sixth turn with a wrench. NOTE: Two harnesses are used with Output Module type 291 132-1. Referring to applicable drawing 209 118 or 209 119, write in the engine firing order below:

10.2

Connect the harness leads in the junction box in accordance with the engine's firing order. The leads from the junction box corresponding to the above system outputs connect to the ignition coil negative(-) terminals. The "P" lead and the common coil ground lead(s) connecting the positive (+) terminals of the ignition coils must be grounded to the engine in the junction box. On V-engines, run a separate common ground lead for each bank. Separate ground connections in the junction box are recommended. Refer to wiring diagrams [209105A](#) (unshielded) or [209106A](#) (shielded) for general details.

10.3

Primary wire should be no. 16 gauge stranded, tinned copper wire. The insulation should have a minimum thickness of .016" and be rated 105°C. or higher. Irradiated PVC or polyolefin insulations are recommended. Altronic primary wire no. 503188 meets these specifications. All primary wiring should be protected from physical damage and vibration.

10.4

If two ignition coils per cylinder connected to a common output are used, use PARALLEL WIRING as shown on the wiring diagrams 209 105A and 209 106A.

10.5

All unused primary wires should be individually taped so that they are insulated from ground and each other. The unused primary wires can then be tie-wrapped together for a clean installation.

11. SHUTDOWN WIRING

11.1

To shut-off the DC-powered CPU-2000 system, a special input (SHUTDOWN INPUT - terminal 4) in the Logic Module is provided. This input is open for normal operation and is connected to engine ground to initiate an ignition shutdown. Use a switch rated 24 Vdc, 0.5 amps. Refer to section 9.6A. and drawing 209 078 for details.

11.2

DO NOT ground leads "N" or "V" to stop the ignition with the CPU-2000 system. This can cause component failure in the Output Module. These leads are provided to power existing ignition powered instruments and for scope analysis only.

12. SECONDARY WIRING

12.1

Mount the ignition coils as close as possible to the engine spark plugs consistent with a secure mounting and avoidance of temperatures in excess of 185°F (85°C.).

12.2

The spark plug leads should be fabricated from silicone insulated 7 mm cable with suitable terminals and silicone spark plug boots. The use of leads with resistor spark plug boots (Altronic series 59320x-xx) is recommended to minimize interference from emitted RFI on the operation of other nearby electronic equipment. Another option is the use of suppression ignition cable (Altronic part no. 503185). It is also essential to keep spark plug leads as short as possible and in all cases not longer than 24 inches (600 mm). Spark plug leads should be kept at least 2 inches (50 mm) away from any grounded engine part. In deep spark plug wells, use rigid insulated extenders projecting out of the well.

12.3

The use of a clear, silicone grease (such as Dow Corning DC-4, G.E. G-623 or GC Electronics ZS) is recommended for all high-tension connections and boots. This material helps seal out moisture and

prevent corrosion from atmospheric sources.

13. Figures

13.1 Wiring Diagram



13.2 Timing Curve

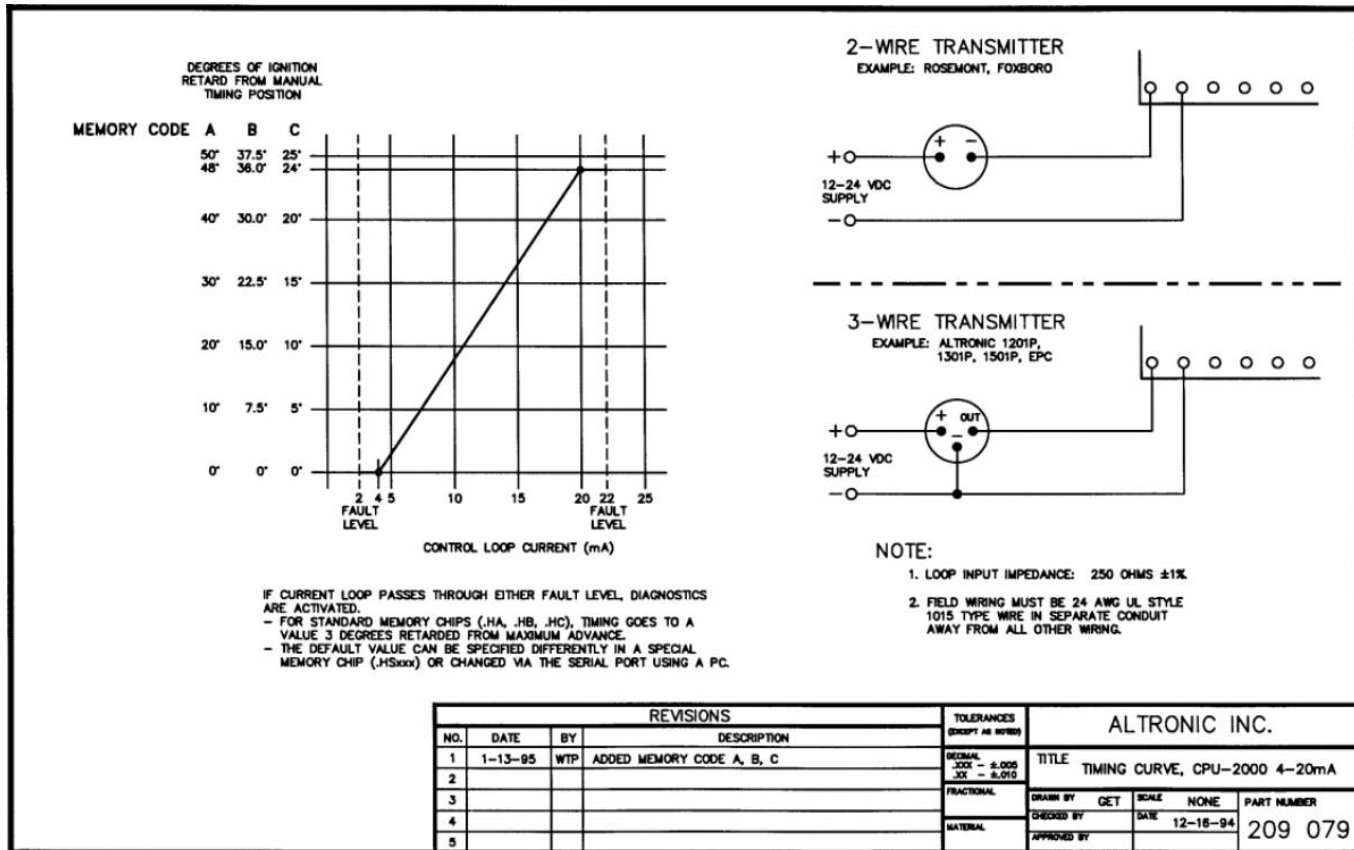

13.3 Pickup Mounting

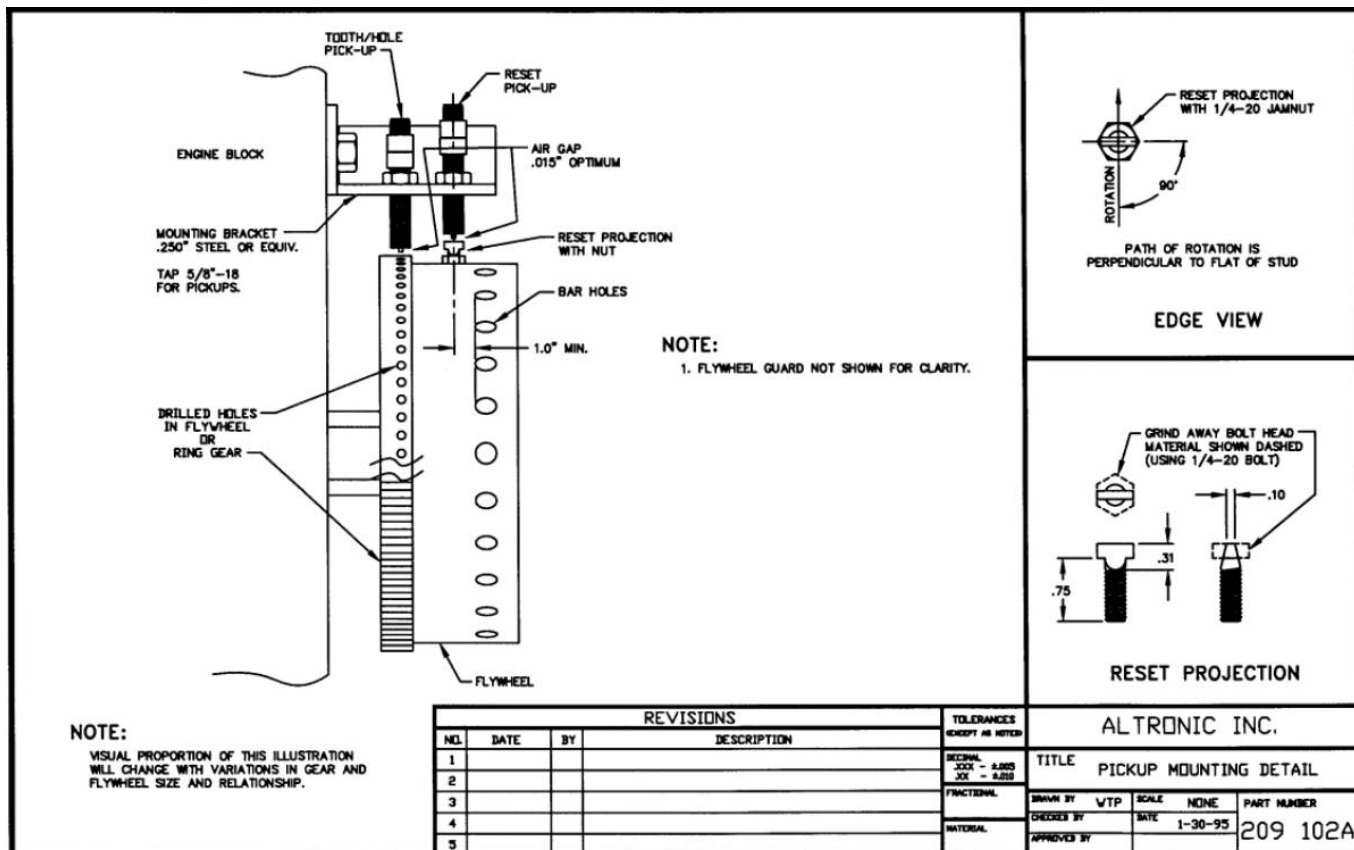

13.4 Flywheel Hole Drilling

FLYWHEEL LAYOUT

MARK "A" AND MEASURE CIRCUMFERENCE A→A

MEASURE 1/2A→A AND MARK "B"
NOTE: A→B = B→A

MEASURE 1/2A→B AND MARK "C"
MEASURE AND MARK "D" IN THE SAME MANNER

MEASURE 1/2A→C AND MARK "E"
MEASURE AND MARK "F", "G", AND "H" IN THE SAME MANNER
NOTE: CONFIRM INTERVALS BETWEEN MARKS ARE NOW EQUAL

MEASURE THE LENGTH A→E, DIVIDE BY 45, AND BEGINNING WITH "A" MARK OFF INTERVALS OF THIS LENGTH TO "E", COUNTING "A" AND "E" THERE SHOULD BE 46 MARKS.
DO THE REMAINING 7 SECTIONS IN THE SAME MANNER.

PROCEDURE FOR DRILLING 360 HOLES IN ENGINE FLYWHEEL

DRILLING DETAIL

TIMING HOLES

FLYWHEEL

BAR HOLES

RESET PROJECTION

1" MIN. 1" MIN.

2/3 "N" .50 MIN. "N" 1/3 "N" TIMING HOLES

DISTANCE $N = \frac{A \text{ TO } E}{45}$

NOTE: IF 2/3 "N" WORKS OUT TO BE BETWEEN STANDARD DRILL SIZES - USE NEXT SIZE LARGER.

REVISIONS				TOLERANCES		ALTRONIC INC.			
NOL	DATE	BY	DESCRIPTION	EXCEPT AS NOTED		TITLE			
1	10-19-90	WTP	REDRAWN ON CAD; UPDATED	DECIMAL	XXX - 0.005	FLYWHEEL HOLE DRILLING			
2	3-12-91	WTP	UPDATED	FRACTIONAL	XXX - 0.010	DRAWN BY	DA	SCALE	NONE
3				MATERIAL		CHECKED BY	DATE	5-29-85	PART NUMBER
4						APPROVED BY			209 103
5									

13.5 Wiring Diagram Unshielded

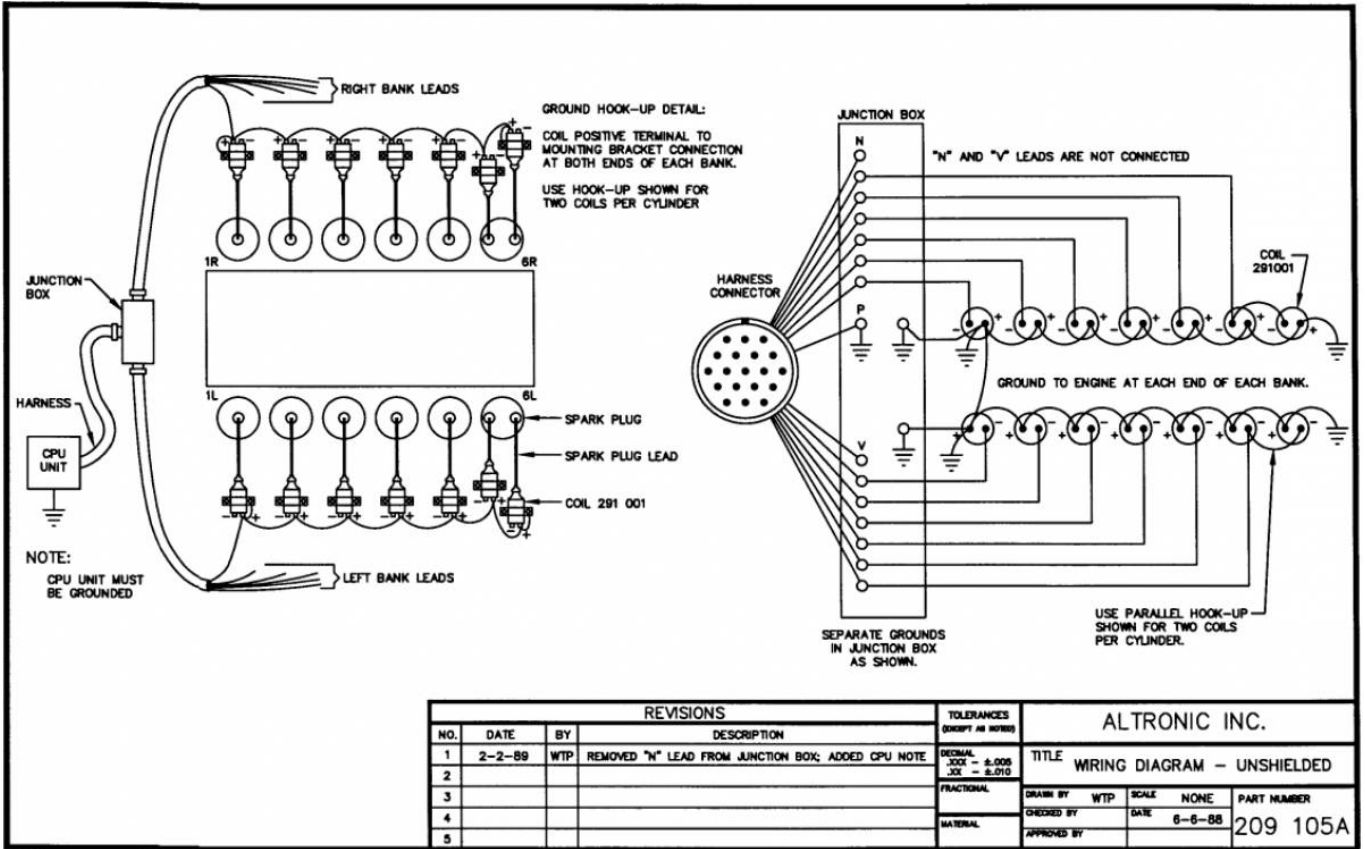

13.6 Wiring Diagram Shielded

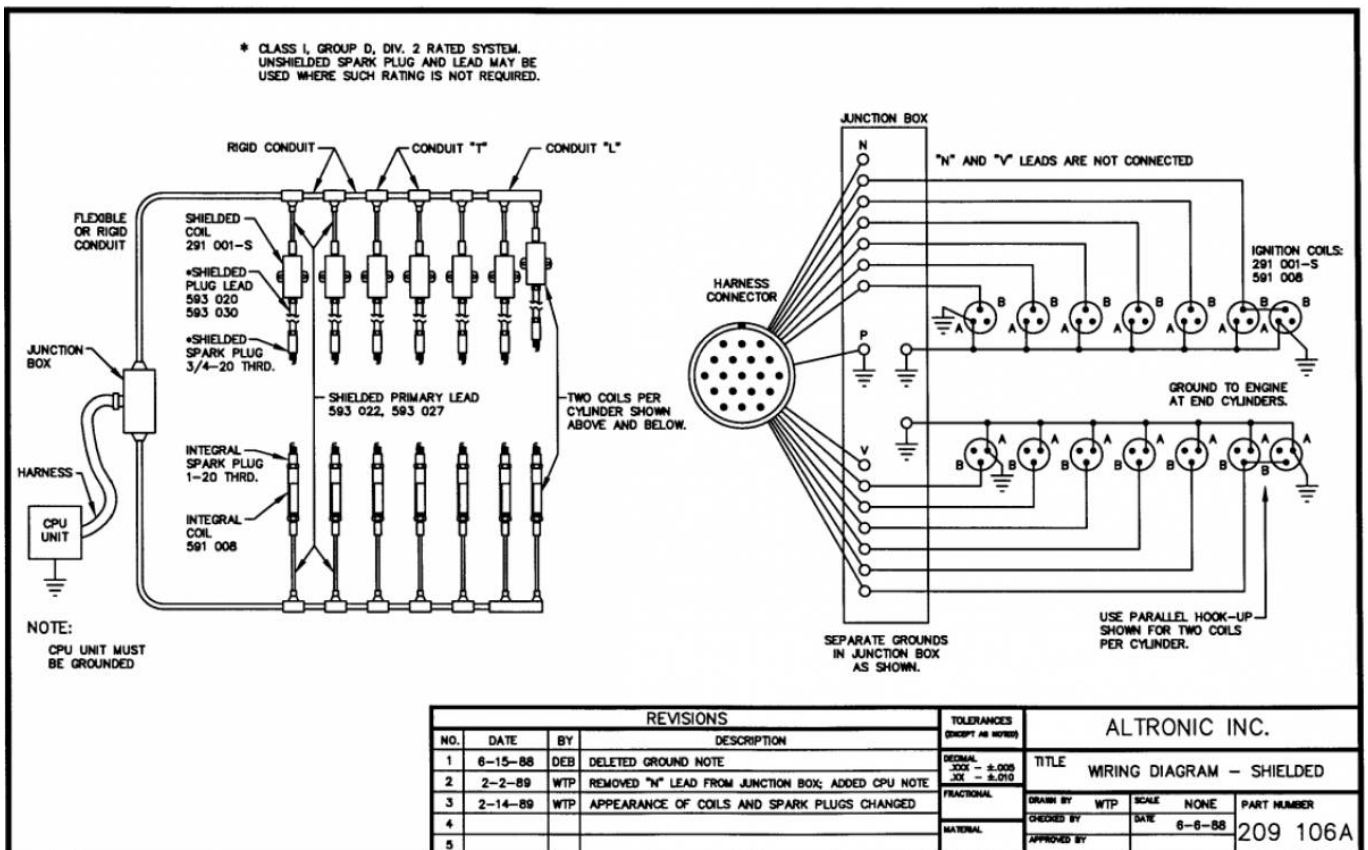

13.7 Hookup Diagram Dual Output

NO. OUTPUTS	MEMORY CODE	IGNITION SYSTEM FIRING ORDER
10	J2x, J4x E6A*, E8A*	A1-A2-B1-B2-C1-C2-D1-D2-E1-E2
12	L2x, L4x F6x*, F8x*	A1-A2-B1-B2-C1-C2-D1-D2-E1-E2-F1-F2
14	N2x, N4x G6A*, G8A*	A1-A2-B1-B2-C1-C2-D1-D2-E1-E2-F1-F2-G1-G2
16	P2x, P4x H6x*, H8x*	A1-A2-B1-B2-C1-C2-D1-D2-E1-E2-F1-F2-G1-G2-H1-H2
18	R2x, R4x I6A*, I8A*	A1-A2-B1-B2-C1-C2-D1-D2-E1-E2-F1-F2-G1-G2-H1-H2-J1-J2
20	T2x, T4x J6x*, J8x*	A1-A2-B1-B2-C1-C2-D1-D2-E1-E2-F1-F2-G1-G2-H1-H2-J1-J2-K1-K2
24	X2x, X4x L6x*, L8x*	A1-A2-B1-B2-C1-C2-D1-D2-E1-E2-F1-F2-G1-G2-H1-H2-J1-J2-K1-K2-L1-L2-M1-M2
32	Z2x, Z4x P6x*, P8x*	A1-A2-B1-B2-C1-C2-D1-D2-E1-E2-F1-F2-G1-G2-H1-H2-J1-J2-K1-K2-L1-L2-M1-M2-R1-R2-S1-S2-T1-T2 U1 U2

* MEMORY CODES WITH 8 OR 8 CYCLE DESIGNATION ARE USUALLY USED FOR WIRING TWO LEADS TO EACH ENGINE CYLINDER. LEADS A1,A2 CONNECT TO THE TWO COILS OF THE SAME CYLINDER. FOLLOW THE SAME HOOK-UP WITH B1,B2 THEN C1,C2, ETC. ALL EVEN-NUMBERED OUTPUTS (A2,B2,C2, ETC.) CAN BE OBTAIN USING THE MISC INPUT TERMINAL OR AT 200 RPM - SEE SECTION 9.6D. AND OPERATING INSTRUCTIONS FORM CPU-2000 OI.

291 132-1 OUTPUT MODULE

REVISIONS				TOLERANCES	ALTRONIC INC.	
NO.	DATE	BY	DESCRIPTION	EXCEPT AS NOTED	TITLE CPU-2000 LIGHTNING PROOFING TEST SIZE 1	
1				DECIMAL XXX = 0.005 XX = 0.010	DRAWN BY VTP SCALE NONE PART NUMBER	
2				FRACTIONAL	CHECKS BY DATE 1-3-93	209 119
3				MATERIAL	APPROVED BY	
4						
5						

13.8 Power Hookup

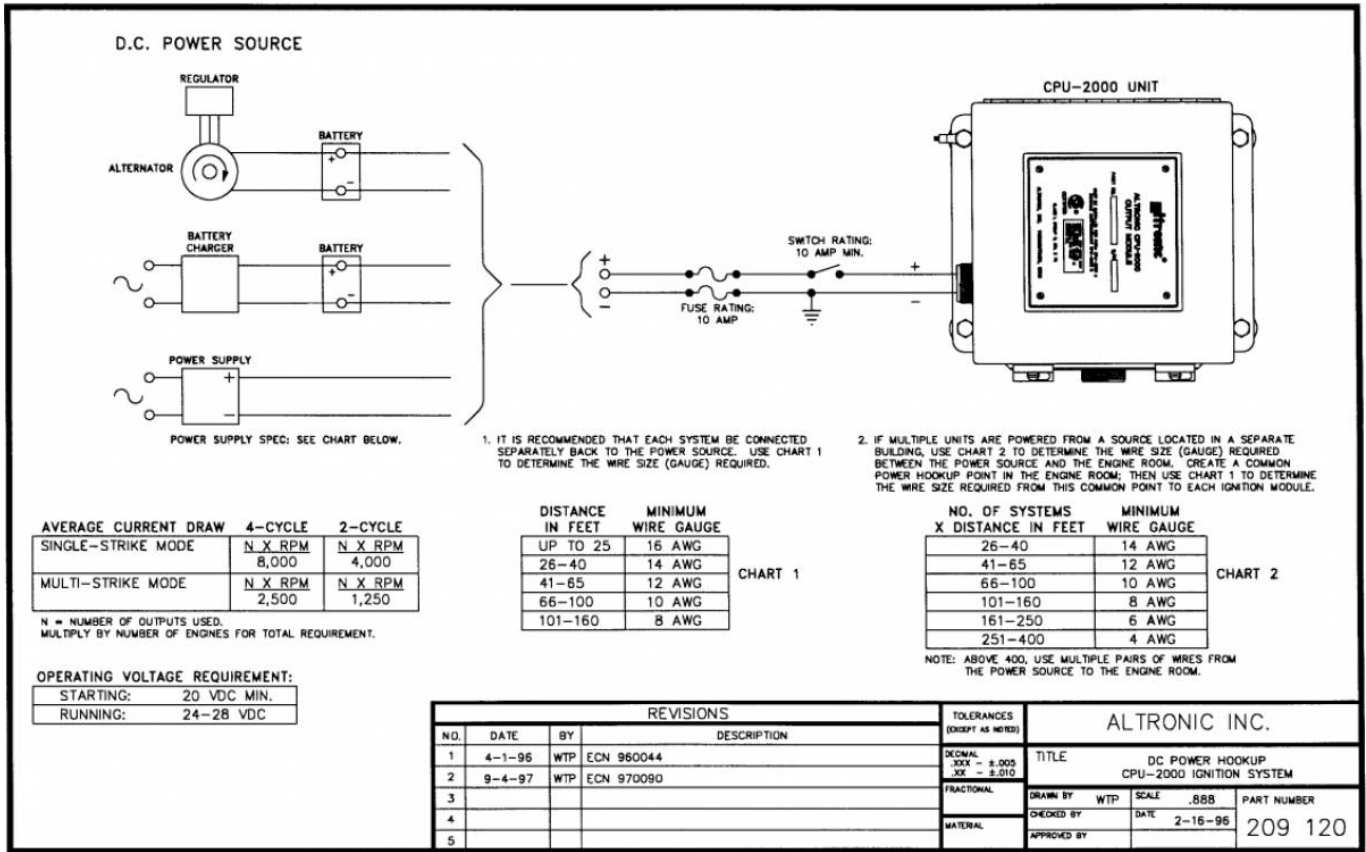

13.9 Wiring Hookup N and V

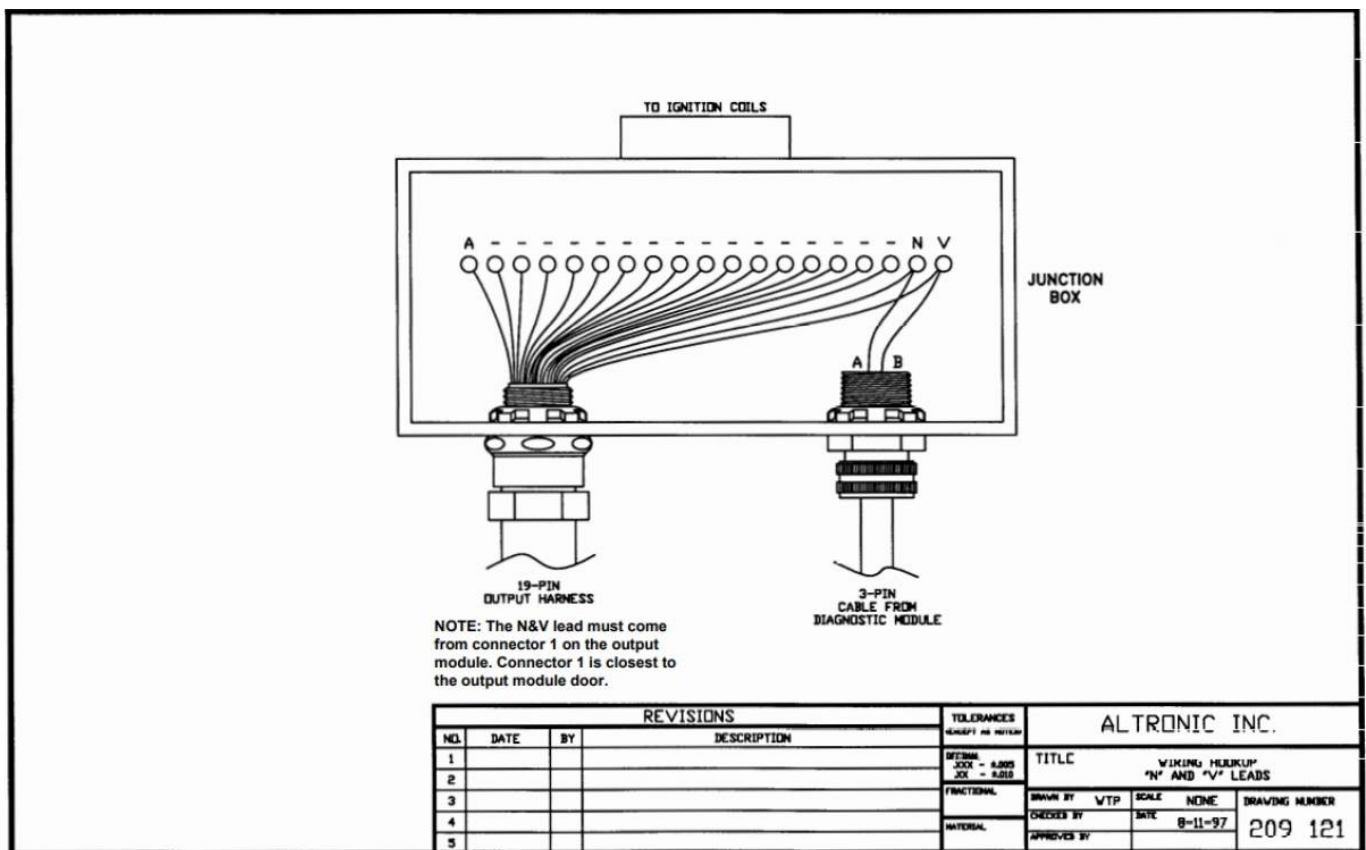

13.10 Output Module Dimensions

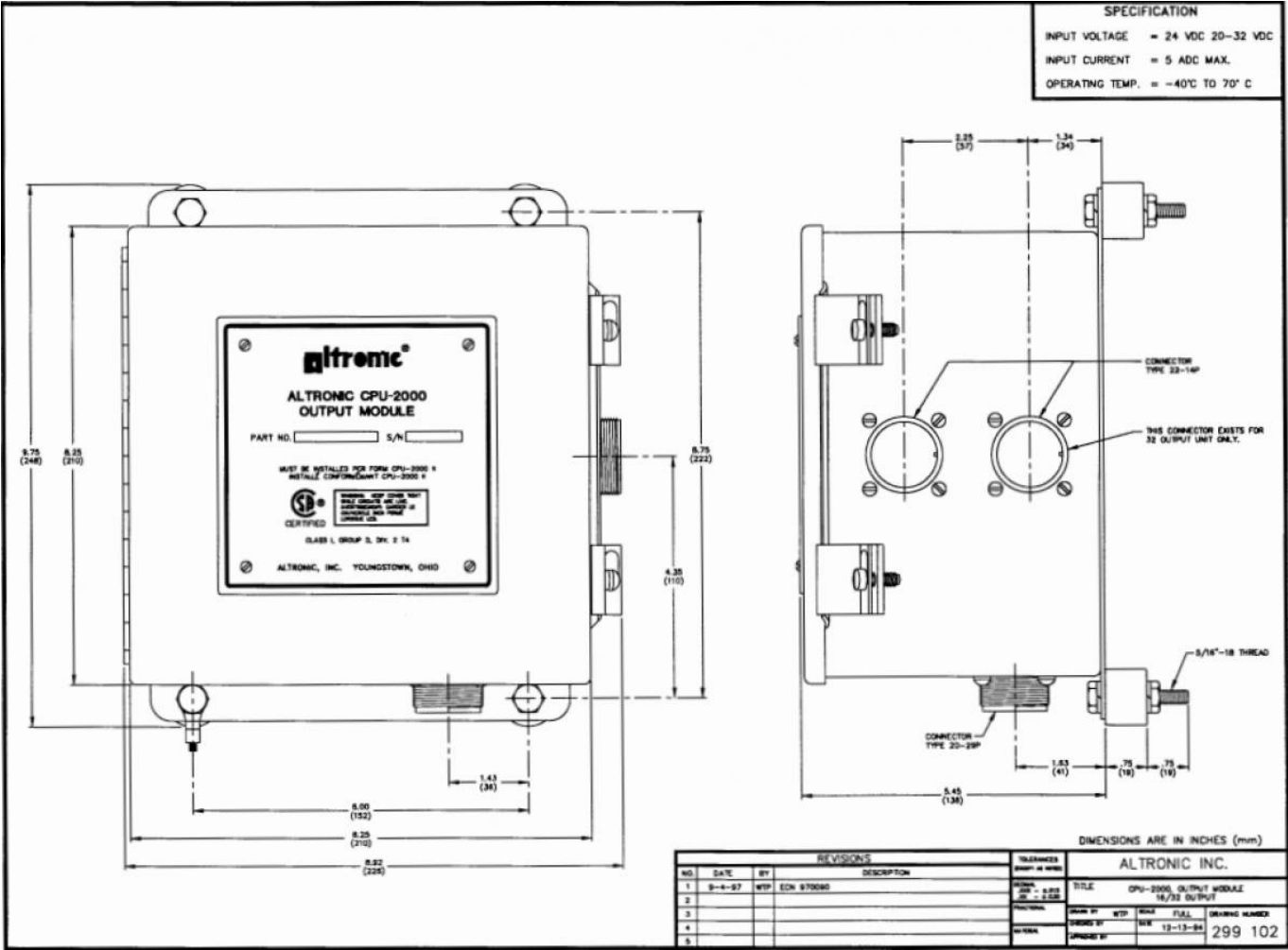

13.11 Diagnostic Module Dimensions

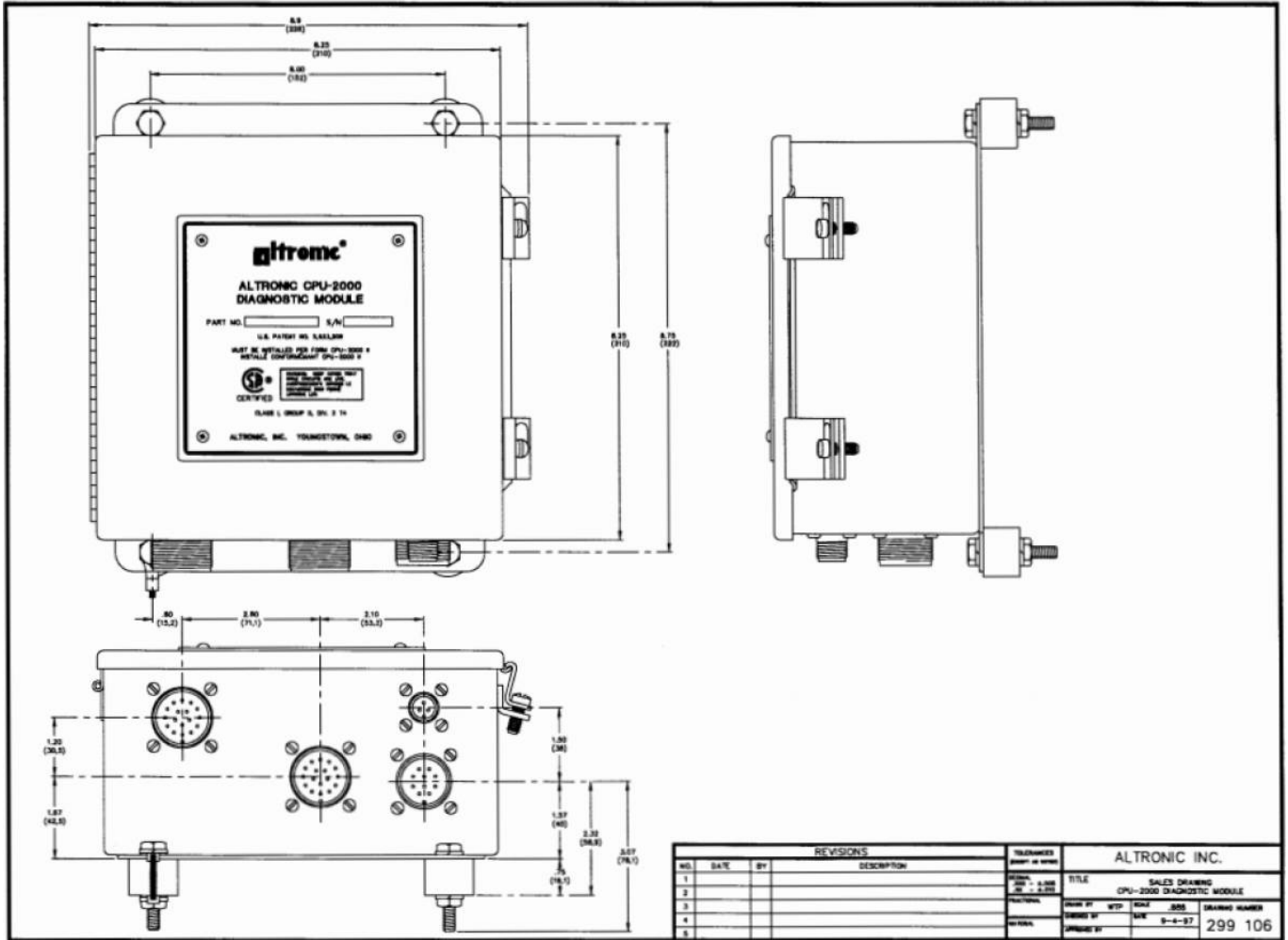

13.12 Shielded Harness



13.13 Shielded Harness



13.14 Conduit Length Adjustment

TO SHORTEN HARNESS

1. LOOSEN AND DISENGAGE NUT (2) AND REMOVE CONDUIT (1) COMPLETELY FROM CONNECTOR AND HARNESS ASSEMBLY (3).
2. REMOVE ITEMS (5), (4), AND (2) IN THAT ORDER FROM CONDUIT (1). NOTE THREADS ON (5).
3. CUT CONDUIT TO LENGTH WITH HACKSAW AND DRESS WITH FILE TO INSURE A CLEAN, SQUARE END. REMOVE FILINGS FROM INSIDE CONDUIT.
4. REINSTALL ITEMS (2), (4), AND (5) IN THAT ORDER.
5. INSTALL REASSEMBLED CONDUIT INTO (3) AND TIGHTEN (2).

REVISIONS				TOLERANCES (EXCEPT AS NOTED)		ALTRONIC INC.		
NO.	DATE	BY	DESCRIPTION	DECIMAL	FRAC.	DRWN BY	SCALE	PART NUMBER
1	3-14-92	WTP	REDRAWN ON CAD	$\pm .005$		DWA	NONE	509 025
2				$\pm .010$				
3								
4								
5								

13.15 Magnet Holder



REVISIONS				TOLERANCES (EXCEPT AS NOTED)	ALTRONIC INC.				
NO.	DATE	BY	DESCRIPTION	DECIMAL .XXX - ±.005 .XX - ±.010	TITLE MAGNET HOLDER SALES DRAWING				
1				FRACTIONAL	DRAWN BY	WTP	SCALE	FULL	PART NUMBER
2				MATERIAL	CHECKED BY		DATE	6-1-90	260 604
3					APPROVED BY				
4									
5									

13.16 Magnet Holder Dimensions



REVISIONS				TOLERANCES (EXCEPT AS NOTED)	ALTRONIC INC.				
NO.	DATE	BY	DESCRIPTION	DECIMAL .XXX - ±.005 .XX - ±.010	TITLE SALES DRAWING, MAGNET HOLDER				
1				FRACTIONAL	DRAWN BY	WTP	SCALE	FULL	DRAWING NUMBER 260 605
2				MATERIAL	CHECKED BY	DATE	6-20-97		
3					APPROVED BY				
4									
5									

13.17 Magnet Assembly



REVISIONS				TOLERANCES (EXCEPT AS NOTED)	ALTRONIC INC.			
NO.	DATE	BY	DESCRIPTION	DECIMAL .XXX - ±.005 .XX - ±.010	TITLE MAGNET ASSEMBLY SALES DRAWING		PART NUMBER 720 002	
1				FRACTIONAL	DRAWN BY	WTP		SCALE
2				MATERIAL	CHECKED BY		DATE	1-27-88
3					APPROVED BY			
4								
5								

13.18 Hall Effect Pickup Dimensions

SPECIFICATIONS:

SUPPLY VOLTAGE: 5 TO 8 VOLTS D.C.
 SUPPLY CURRENT: 50 mA. MAX.
 OUTPUT VOLTAGE @ 5 mA: SUPPLY VOLTAGE MINUS 1.0 VOLT MAX.
 OUTPUT CURRENT SOURCING: 10 mA. MAX.
 STORAGE AND OPERATING TEMP.: -40°C TO +125°C
 -40°F TO +257°F
 ENCAPSULATED IN GLASS-FILLED EPOXY SUITABLE FOR ENGINE OIL OR OTHER NON-CONDUCTIVE MEDIA ONLY.
 MAXIMUM OPERATING PRESSURE: 50 psi DIFFERENTIAL

TYPICAL OUTPUT WAVEFORM

TRIGGERED BY THE NORTH POLE OF MAGNET 5 VOLT SUPPLY 1KΩ LOAD

SCHEMATIC

ALTRONIC P/N

ALTRONIC P/N	T	L
591014-2	2.50"/63.5mm	4.05"/102.8mm
591014-4	4.50"/114.3mm	6.05"/153.7mm

NOTE:

- NORTH POLE OF MAGNET MUST FACE SENSING END WITH AIR GAP OF .030/.040 (.76/.10).
- CENTERLINE OF MAGNET'S ROTATION MUST RUN THROUGH CENTERLINE OF PICKUP.

REVISIONS

NO.	DATE	BY	DESCRIPTION
1	10-8-90	VTP	REDRAWN ON CAD
2	8-6-92	VTP	UPDATED TITLE
3	11-5-96	VTP	ECN 960134
4	9-2-97	VTP	ECN 970105
5			

TOLERANCES
EXCEPT AS NOTED

TOLERANCE	ALTRONIC INC.
DECIMAL	TITLE SALES DRAWING HALL EFFECT PICKUP
FRACTIONAL	DRAWN BY DVA SCALE FULL DRAWING NUMBER
MATERIAL	CHECKED BY DATE 1-26-88 591 014
	APPROVED BY

13.19 Magnetic Pickup Dimensions

***NOTE:**

ELECTRICAL VALUES GIVEN ARE ABSOLUTE RATINGS ASSURED 100% BY TEST.

ELECTRICAL DATA *	
MAX. COIL INDUCTANCE	420 mH
MIN. COIL RESISTANCE	800-1200 Ω

ALTRONIC P/N

ALTRONIC P/N	T	L
691 118-1	1.75"/44.5mm	3.30"/83.3mm
691 118-2	2.50"/63.5mm	4.05"/102.8mm
691 118-3	3.0"/76.2mm	4.55"/115.6mm
691 118-4	4.5"/114.3mm	6.05"/153.7mm
691 118-6	6.0"/152.4mm	7.55"/191.8mm

REVISIONS

NO.	DATE	BY	DESCRIPTION
6	8-7-92	VTP	UPDATED
7			
8			
9			
10			

TOLERANCES
EXCEPT AS NOTED

TOLERANCE	ALTRONIC INC.
DECIMAL	TITLE MAGNETIC PICKUP SALES DRAWING
FRACTIONAL	DRAWN BY DVA SCALE FULL PART NUMBER
MATERIAL	CHECKED BY DATE 3-16-81 691 118
	APPROVED BY

From:

<https://www.staging.altronic.a2hosted.com/> - **wiki STAGING !!!!!**

Permanent link:

<https://www.staging.altronic.a2hosted.com/doku.php?id=documents:ngi-5000-logic:ngi5000installation&rev=1677437890>

Last update: **2023/02/26 13:58**